

ENS 3000 POLYMER CONCRETE DRAINAGE CHANNEL BODY WITH AN INTEGRATED DIECAST FRAME GENERAL BUILDING AUTHORITY APPROVAL Z - 74.4 - 28

Clear width of the drainage channel body 300mm, total width 394mm. Water level slope. Loading classes A 15 to F 900** according to EN 1433. Suitable for **MEADRAIN Top ENS 3000** drainage channel covers. Load capacity according to specification, when installed according to the MEA installation instruction.

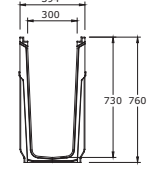

MEADRAIN ENS 3000 | MEADRAIN ENS 3070 | MEADRAIN SK-UT

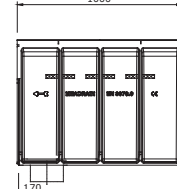
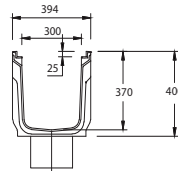
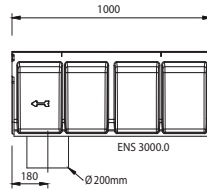

MEADRAIN EN 3000 with connection piece | MEADRAIN ENS 3070

Drainage channel body MEADRAIN ENS 3000 without fall

MG	Designation	Length/ mm	Total height/ mm	EDP-No. 010...	kg/unit	units/pallet
MD	MEADRAIN ENS 3000.0 ¹⁾	1000	400	153751	66.10	6
MD	MEADRAIN ENS 3000.0/A ²⁾	1000	400	153753	66.10	6
MD	MEADRAIN ENS 3000.1 ¹⁾	500	400	153755	32.30	12

1) Connection option for vertical drain Ø 200 mm or an intake/sediment bucket.

2) With formed-in flanged drain socket Ø 200mm made of HD-PE with NBR O-sealing ring.

Drainage channel body MEADRAIN ENS 3070 without fall

MG	Designation	Length/ mm	Total height/ mm	EDP-No. 010...	kg/unit	units/pallet
MD	MEADRAIN ENS 3070.0 ¹⁾	1000	760	712401	107.00	6
MD	MEADRAIN ENS 3070.1 ¹⁾	500	760	712399	51.00	12
MD	MEADRAIN ENS 3070.0/A ²⁾	1000	760	712403	109.30	6

1) Connection option for vertical drain Ø 200 mm or an intake/sediment bucket.

2) With formed-in flanged drain socket Ø 200mm made of HD-PE with NBR O-sealing ring.

MEADRAIN ENS 3000 ACCESSORIES

Gully made of polymer concrete, edge protection made of cast iron, sediment bucket

MG	Designation	Length/ mm	Total height/ mm	EDP-No. 010...	kg/unit	units/pallet
MD	MEADRAIN ENS 3000 SK-OT gully- top ³⁾	500	550	153773	37.00	6
MD	MEADRAIN SK-ZT middle gully section	524	390	154709	22.00	12
MD	MEADRAIN SK-UT lower gully section short with integrated outlet connector Ø 160mm	524	335	154726	25.60	4
MD	MEADRAIN SK-UT lower gully section short with integrated outlet connector Ø 200mm	524	335	154728	25.70	4
MD	MEADRAIN ENS 3000 sediment bucket short for gullies consisting of SK-OT without intermediate	-	-	154713	4.50	60
MD	MEADRAIN ENS 3000 sediment bucket long for gullies consisting of SK-OT without intermediate	-	-	154715	6.00	1
MD	MEADRAIN SK-UT short variant without DIBt approval. Lower part gully "short" with moulded inserts for connection of drains Ø 160mm and Ø 200mm	524	350	154711	24.00	12
MD	MEADRAIN SK-UT deep version without DIBt approval. Lower part gully "deep" with moulded inserts for connection of drains Ø 160mm and Ø 200mm	524	485	154719	33.60	8

1) Connection option for vertical drain Ø 200 mm or to an inlet/gully.

2) With moulded-in Ø 200 mm drain socket made of HD-PE with NBR-O sealing ring.

3) Only for connection to ENS 3000 channel, not suitable for ENS 3070 channel.

> **NOTE** ** Starting from class D 400 not suitable for the diagonal or transverse travel of motorways and highways.

MEADRAIN EN 3000 AND ENS 3070 ACCESSORIES

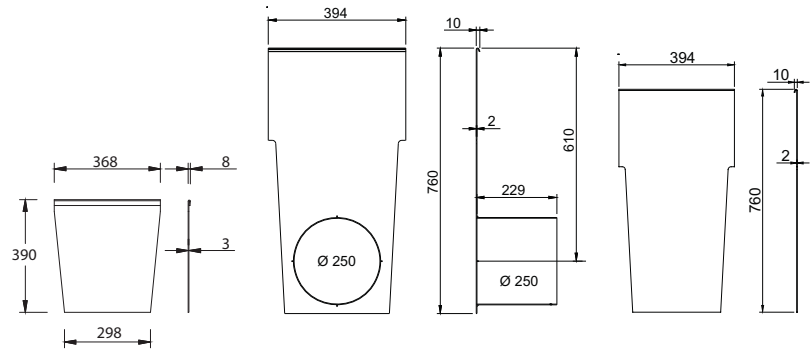

MEADRAIN End caps: ENS 3000 | ENS 3070 | ENS 3070.SE

End cap for MEADRAIN ENS 3000 made of galvanised steel

MG	Designation	Material	EDP-No. 010...	kg/unit	units/pallet
MD	MEADRAIN ENS 3000.SE End cap for channel start/end	Galv. steel	153777	0.40	1

End cap for MEADRAIN ENS 3070 made of polymer concrete with cast iron edge protection

MG	Designation	Material	EDP-No. 010...	kg/unit	units/pallet
MD	MEADRAIN ENS 3070.SE End cap for channel start/end	Galv. steel	712408	0.50	1
MD	MEADRAIN ENS 3070.F End cap for the channel end with socket Ø 250mm	Galv. steel	712406	0.80	1

NBR lip sealing ring

MG	Designation	Material	EDP-No. 010...	kg/unit	units/pallet
MD	NBR lip seal ring Ø 200mm made of highly resistant synthetic rubber for the liquid-tight connection of the sludge bucket drainage pre-forming	NBR	153889	0.07	1

SEALANTS FOR MEADRAIN ENS 3000 AND ENS 3070

for sealing the channel joints of channels with sealing joint.*

Sealants for standard applications*

MG	Designation	Material	EDP-No. 010...	kg/unit	units/pallet
PG	SABA MS Floor Sealant 600 ml in bag, stable	MS-Polymer-Basis	152708	0.84	1
PG	SABA Primer 9102, 1 litre	Silane basis	155803	0.90	1
PG	Joint Cleaner SABAClean 48, 1 litre, Cleaner for adhesive flanks	-	155807	0.81	1
PG	Dispensing gun for 600 ml bags	-	152707	0.79	1

* Exclusively for the sealing of channel systems exposed to rain water. Not suitable for the utilization in LAU plants, gas stations and similar building projects.

> **NOTE** ** Starting from class D 400 not suitable for the diagonal or transverse travel of motorways and highways.

MEADRAIN TOP 3000 PROFIX CHANNEL COVERS

With non-bolted PROFIX channel cover securement. Suitable for the systems **MEADRAIN ENS 3000** and **ENS 3070**. With longitudinal shift protection. For drainage channel bodies and gully. Total width of grates 346mm.

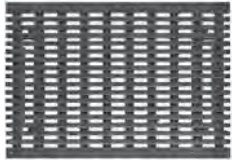

ADA longitudinal rod die-cast grating 31/7,7

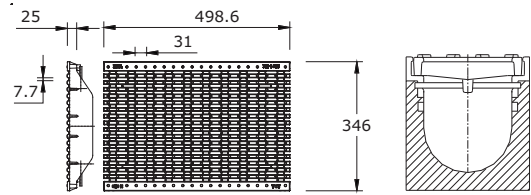

ENS 3000 ADA longitudinal cast iron grate 31/7,7 with PROFIX | PROFIX

Loading class E 600 according to EN 1433 with non-bolted PROFIX channel securement

MG	Designation	Material	Length/mm	EDP-No. 010...	Inlet sect. area \emptyset cm ² /m	kg/unit	units/pallet
MD	ADA longitudinal rod die-cast grating 31/7,7	Die-cast GGG	500	152551	950	23.00	30

1) The grate corresponds to the ADA regulations (Americans Disabilities Act) for a handicapped accessible method of construction. Ideally suited for wheelchair and bicycle driving and for pedestrian traffic. Slot widths transverse to the travel direction under 13mm. Slot widths transverse under 40mm. Sliding-inhibiting elevations under 3mm. Sliding-inhibiting surface (die-cast).

Grid hook

MG	Designation	Material	EDP-No. 010...	kg/unit	units/pallet
MD	Grid hook	Galv. steel	152115	1.00	1



Cast iron slotted grating

Cover closed

MEADRAIN TOP 3000 4-FOLD BOLTED CHANNEL COVERS

Suitable for the systems **MEADRAIN ENS 3000** and **ENS 3070**.

Loading class F 900 according to EN 1433 with non-bolted PROFIX channel securement

MG	Designation	Material	Length/mm	EDP-No. 010...	Inlet sect. area \emptyset cm ² /m	kg/unit	units/pallet
MD	Cast iron slotted grating 30/148	Die-cast GGG	500	712411	1780	26.00	35
MD	Cast iron slotted grating 16/148	Die-cast GGG	500	710812	1400	28.80	35
MD	Cast iron cover closed	Die-cast GGG	500	710810	-	34.60	1

Grating fixation

MG	Designation	Material	EDP-No. 010...	kg/unit	units/pallet
MD	Grating fixation screw M 10 + square nut, 4 pieces/grating needed, tightening torque 20 Nm	Galv. steel	154859	0.06	1

> **NOTE** The surface coating of die-cast parts only has a temporary and cosmetic function. Cast iron is virtually impervious to surface oxidation from environmental influences (e.g. thawing salt). Superficial rust does not constitute a product defect. It goes without saying that even the absence of surface coating complies with the relevant standards.

MEADRAIN DRAINAGE SYSTEM | CW 400

A 15 B 125 C 250 D 400** E 600** F900**

MEADRAIN ENS 4000 POLYMER CONCRETE DRAINAGE CHANNEL BODY WITH AN INTEGRATED DIECAST FRAME AND SEALING JOINT GENERAL BUILDING AUTHORITY APPROVAL Z - 74.4 - 28

Clear width of the drainage channel body 400mm, total width 494mm. Suitable for the drainage channel cover **MEADRAIN Top 4000**. For the realization of water level slopes. Loading classes A 15 to F 900** according to DIN EN 1433.

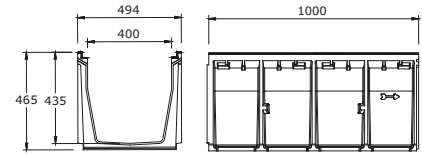

MEADRAIN ENS 4000

Drainage channel body in special height, without fall

MG	Designation	Length/ mm	Total height/ mm	EDP-No. 010...	kg/unit	units/pallet
MD	MEADRAIN ENS 4000.0 ¹⁾	1000	465	152001	71.20	4
MD	MEADRAIN ENS 4000.1 ¹⁾	500	465	152003	35.00	8
MD	MEADRAIN ENS 4000.0/A ²⁾	1000	465	152002	68.00	4

1) Connection option for vertical drain Ø 200mm or to a sediment bucket.

2) With moulded-in drain socket Ø 200mm made of HD-PE with NBR-O sealing ring.

MEADRAIN ENS 4000 ACCESSORIES



MEADRAIN ENS 4000 SK-OT | SK-UT deep | SK-UT short

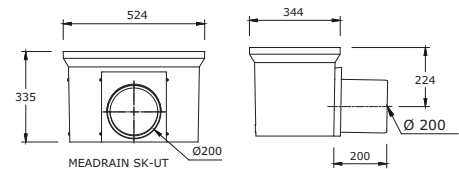

MEADRAIN SK-UT drain socket Ø 200mm

Gully made of polymer concrete for MEADRAIN ENS 4000, cast iron edge protection

MG	Designation	Length/ mm	Total height/ mm	EDP-No. 010...	kg/unit	units/pallet
MD	MEADRAIN ENS 4000 SK-OT gully upper part with integrated cast iron edge	1000	632	152009	79.00	8
MD	MEADRAIN SK-ZT gully -intermediate part made of polymer concrete for height extension	524	390	154709	22.00	12
MD	MEADRAIN SK-UT lower gully section short with integrated outlet connector Ø 160mm	524	335	154726	25.60	4
MD	MEADRAIN SK-UT lower gully section short with integrated outlet connector Ø 200mm	524	335	154728	25.70	4
MD	MEADRAIN SK-SK sediment bucket short for gully consisting of: SK-OT and SK-UT	-	-	154713	4.50	60
MD	MEADRAIN SK-SL sediment bucket long for gully consisting of: SK-OT, SK-ZT and SK-UT	-	-	154715	6.00	1
MD	MEADRAIN SK-UT short variant without DIBt approval. Lower part gully "short" with moulded inserts for connection of drains Ø 160mm and Ø 200mm	524	335	154711	24.00	12
MD	MEADRAIN SK-UT deep version without DIBt approval. Lower part gully "deep" with moulded inserts for connection of drains Ø 160mm and Ø 200mm	524	485	154719	33.60	8

> **NOTE** ** Starting from class D 400 not suitable for the diagonal or transverse travel of motorways and highways.

MEADRAIN ENS 4000 ACCESSORIES

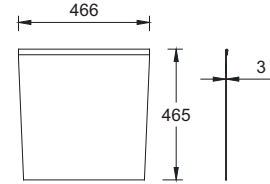

MEADRAIN ENS 4000 end cap

End cap, galvanised steel

MG	Designation	Material	EDP-No. 010...	kg/unit	units/pallet
MD	MEADRAIN ENS 4000.SE End cap for channel start/end	Galv. steel	152005	3.30	1

SEALANTS FOR MEADRAIN ENS 4000

for sealing the channel joints of channels with sealing joint.*

MG	Designation	Material	EDP-No. 010...	kg/unit	units/pallet
PG	SABA MS Floor Sealant, 600ml bag	-	152708	0.84	15
PG	Joint Cleaner solvent 48,1 litre, Cleaner for adhesive flanks	-	155807	0.81	12
PG	SABA Primer 9102, 1 litre	Silane basis	155803	0.90	1
PG	Dispensing gun for 600ml bag	-	152707	0.79	1

* Exclusively for the sealing of channel systems exposed to rain water. Not suitable for the utilization in LAU plants, gas stations and similar building projects.

MEADRAIN TOP 4000 4-FOLD BOLTED CHANNEL COVERS

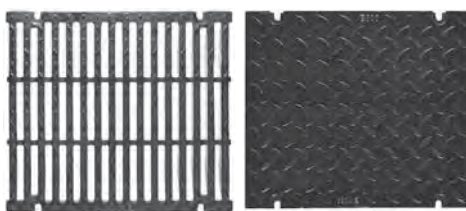

Cast iron slotted grating

Closed cover

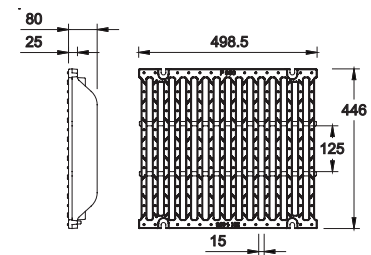

010152017

Cast iron web grating 15/126 Loading class F 900, 4-fold bolted

Loading class D 600 according to EN 1433, 4-fold bolted

MG	Designation	Material	Length/mm	EDP-No. 010...	Inlet sect. area θ cm ² /m	kg/unit	units/pallet
MD	Cast iron slotted grating 15/125	Die-cast GGG	500	154858	1780	37.70	1
MD	Cast iron cover closed	Die-cast GGG	500	154856	-	45.20	1

Loading class D 900 according to EN 1433, 4-fold bolted

MG	Designation	Material	Length/mm	EDP-No. 010...	Inlet sect. area θ cm ² /m	kg/unit	units/pallet
MD	Cast iron slotted grating 15/125	Die-cast GGG	500	152017	1780	40.50	30

Grating fixation

MG	Designation	Material	EDP-No. 010...	kg/unit	units/pallet
MD	Grating fixation screw M 10 + square nut, 4 pieces/grating needed, tightening torque 20 Nm	Galv. steel	154859	0.06	1