

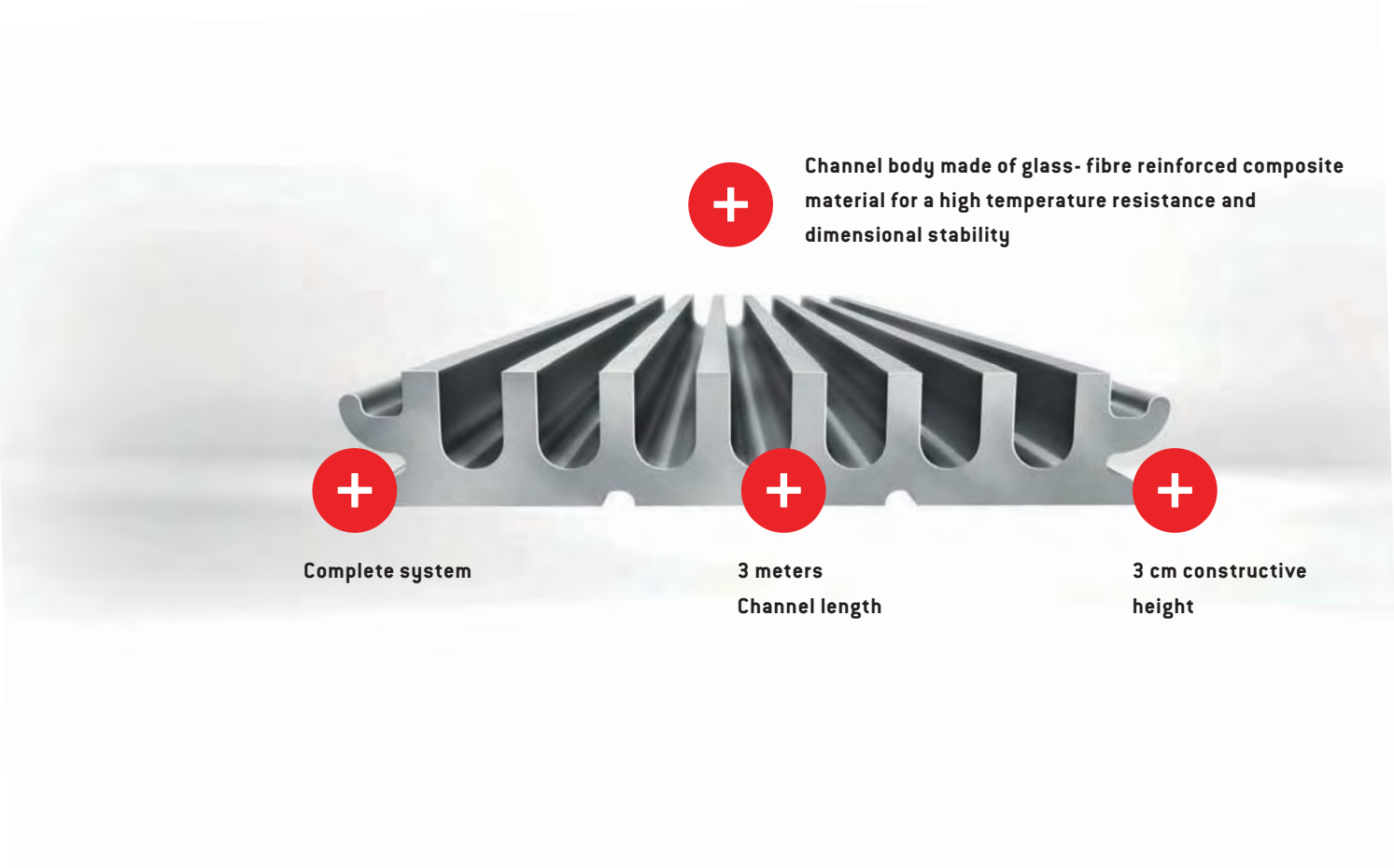

MEARIN PG EVO 150

The multi-storey car park drainage channel MEARIN PG EVO 150 is the next evolution of our bestseller MEADRAIN PG. The new MEARIN PG EVO 150 offers the same advantages as the MEADRAIN PG but also includes some unique features, making the MEARIN PG EVO the new benchmark when it comes to multi-storey and underground car park drainage. Thanks to its monolithic construction and ingenious comb profile, the MEARIN PG EVO 150 multi-storey car park channel is the perfect drainage solution for underground garages and multi-storey car parks. The further optimised construction height (3 cm) and the unique geometry enable the economical and safe installation with an optimum drainage. The MEARIN PG EVO 150 complies with future installation regulations and standards, and is absolutely waterproof.

- Advantages**
- ✓ 3 cm constructive height
 - ✓ Reduction of sealing points thanks to 3 meter of channel length
 - ✓ Sealable, de-icing salt and chemical-resistant
 - ✓ Loading classes up to F 900
 - ✓ Particularly stable and weather resistant
 - ✓ Has a high lateral pressure firmness
 - ✓ Has a smooth surface
 - ✓ Has a comparable length extension to that of reinforced concrete
 - ✓ Consists of capillary-free material



+ Channel body made of glass- fibre reinforced composite material for a high temperature resistance and dimensional stability

+ Complete system

+ 3 meters Channel length

+ 3 cm constructive height

MEARIN PG EVO 150 | TOTAL WIDTH 180

A 15 B 125 C 250 D 400** E 600** F 900**

NEW

MEARIN PG EVO FOR MULTI-STOREY CAR PARKS MADE OF GLASS-FIBRE-REINFORCED COMPOSITE WITH COMB PROFILE, SEALABLE CHANNEL JOINTS, ACCORDING TO EN 1433.

Drainage channels made of glass-fibre-reinforced composite, width 180 mm. For the realization of water level slopes. Low construction height of 30mm, and reduction of the butt seals through a length of 3000 mm. Available in 2 colours (grey, black)** as standard, other colours on request. Loading class A 15 to F 900** according to EN 1433. Load capacity according to specification, when installed according to the MEA installation instructions.

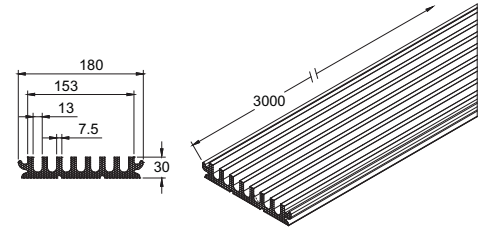
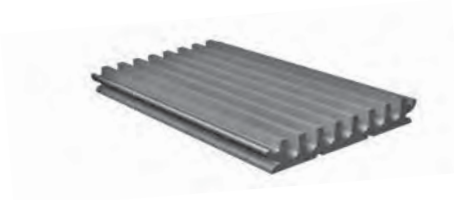

MEARIN PG EVO 150 GREY / BLACK

MEARIN PG EVO 150 multi-storey car park channel made of glass-fibre-reinforced composite in grey or black loading classes A 15 to F 900 according to EN 1433**

MG	Designation	Length/ mm	Total height/ mm	EDP-No. 010...	kg/unit	units/pallet
PG	MEARIN PG EVO 150 GREY channel, including sealing flange	3000	30	141800	17.10	1
PG	MEARIN PG EVO 150 BLACK channel, including sealing flange	3000	30	141814	17.10	1

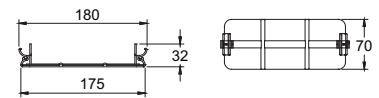

MEARIN PG EVO 150.V multi-storey car park connector

MEARIN PG EVO 150 multi-storey car park channel made of glass-fibre-reinforced composite

MG	Designation	Material	EDP-No. 010...	kg/unit	units/pallet
PG	MEARIN PG EVO 150.V connectors to connect the PG EVO channels, and definition of the butt joint width (colour: grey)	PC-GF	141802	0.04	1

> **NOTE** * Additional colours available from an order quantity of more than 1000 channel meters. Please contact our application engineering department under phone: +49(0)8251-91-1848 or -1385.

** From loading class D400 not suitable for cross drainage of high speed roads and motorways.

NEW

MEARIN PG EVO FOR MULTI-STOREY CAR PARKS ACCESSORIES

Drainage channels made of glass-fibre-reinforced composite, width 180 mm. For the realization of water level slopes. Low construction height of 30 mm, and reduction of the butt seals through a length of 3000 mm. Available in 2 colours (grey, black)** as standard, other colours on request. Loading class A 15 to F 900** according to EN 1433. Load capacity according to specification, when installed according to the MEA installation instructions.

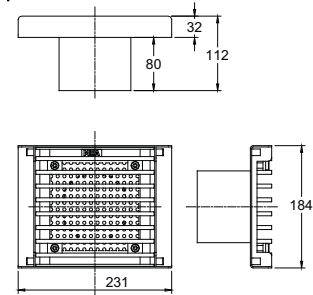

MEARIN PG EVO.EK drainage V2A | Drain connection Ø 110mm

MEARIN PG EVO 150.EK multi-storey car park channel drainage element Ø 110 made of V2A stainless steel, total width 184 mm

MG	Designation	Length/ mm	Total height/ mm	EDP-No. 010...	kg/unit	units/pallet
PG	MEARIN PG EVO 150.EK drain Ø 110 mm incl. longitudinal rod cover matching the 4-fold screw connection and dirt filter appearance. Can be used for subsequent odour trapping.	231	32	141804	3.70	1

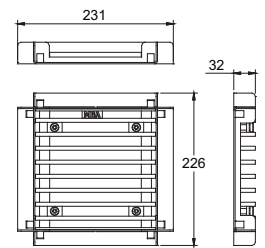

MEARIN PG EVO 150.K crossing element V2A

MEARIN PG EVO 150.K multi-storey car park channel crossing element made of V2A stainless steel, total width 226 mm

MG	Designation	Length/ mm	EDP-No. 010...	kg/unit	units/pallet
PG	MEARIN PG EVO 150.K crossing element incl. longitudinal rod cover, matching the channel appearance with 4-fold screw connection. Up to 4-sided gutter connection possible. - Additional V2A end caps are required for closing the open sides.	231	141806	3.10	1

> **NOTE** When installing the channels with our installation system, an additional installation set is required for each drainage and/or crossing element.
 ** From loading class D400 not suitable for cross drainage of high speed roads and motorways.

MEARIN PG EVO 150 | TOTAL WIDTH 180

A 15 B 125 C 250 D 400** E 600** F 900**

NEW

MEARIN PG EVO FOR MULTI-STOREY CAR PARKS ACCESSORY

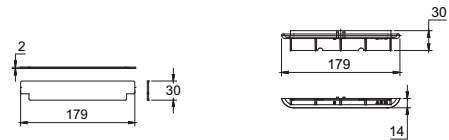

MEARIN PG EVO 150.SE end cap | MEARIN PG EVO 150 V2A end cap

MEARIN PG EVO 150 End caps

MG	Designation	Material	EDP-No. 010...	kg/unit	units/pallet
PG	MEARIN PG EVO 150.SE end cap for the channel beginning and end, with integrated sealing flange for OS coatings and mastic asphalt pavements	PC	141808	0.02	1
PG	MEARIN PG EVO 150 V2A stainless steel end cap, suitable for PG EVO 150 drain and crossing elements	Stainl. steel	141826	0.02	1

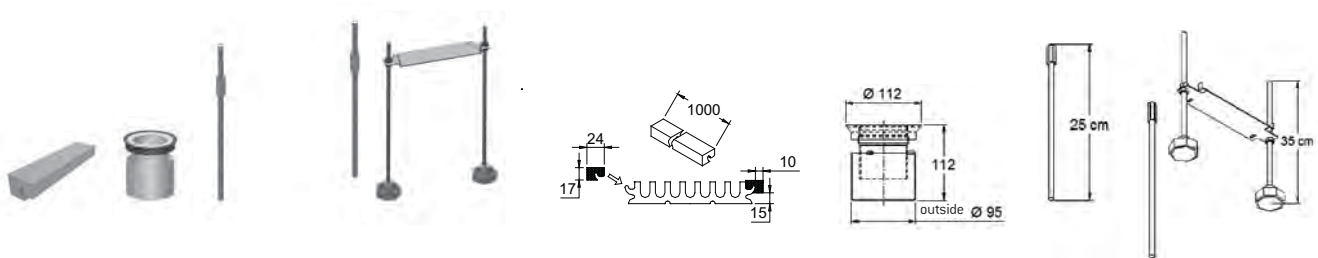

MEARIN PG EVO 150. grouting installation aid | MEARIN PG EVO 150.GV Odour trap | Extension | MEARIN PG EVO 150.AS

MEARIN PG EVO 150 installation, odour trap and joint mounting aid

MG	Designation	Material	EDP-No. 010...	kg/unit	units/pallet
PG	MEARIN PG EVO 150.AS installation set, standard height 35 cm. (Required quantity: 2x per 3 Meter channel +1).- Place every second installation directly underneath the connectors	Galv. steel Stainl. steel Plastic	141810	0.50	1
PG	MEARIN PG EVO.AS extension 25 cm. Extension set for PG EVO.AS installation (2 rods with nuts)	Galv. steel	141824	0.20	1
PG	MEARIN PG EVO 150.GV odour trap V2A. Suitable for PG EVO 150.EK drain element Ø 110 mm	Stainl. steel	141812	0.45	1
PG	MEARIN PG EVO joint mounting aid, length 2 meters, fire behaviour according to DIN 4102-1, B1-flame resistant, max. application temperature for 1 hour > 200°C, according to DIN EN ISO 2578	Melamine resin foam material	141828	0.01	1

> **NOTE** When installing the gutters with our extension an additional mounting set per drain and / or crossing element is required.

NEW

MEARIN PG EVO FOR MULTI-STOREY CAR PARKS ACCESSORIES

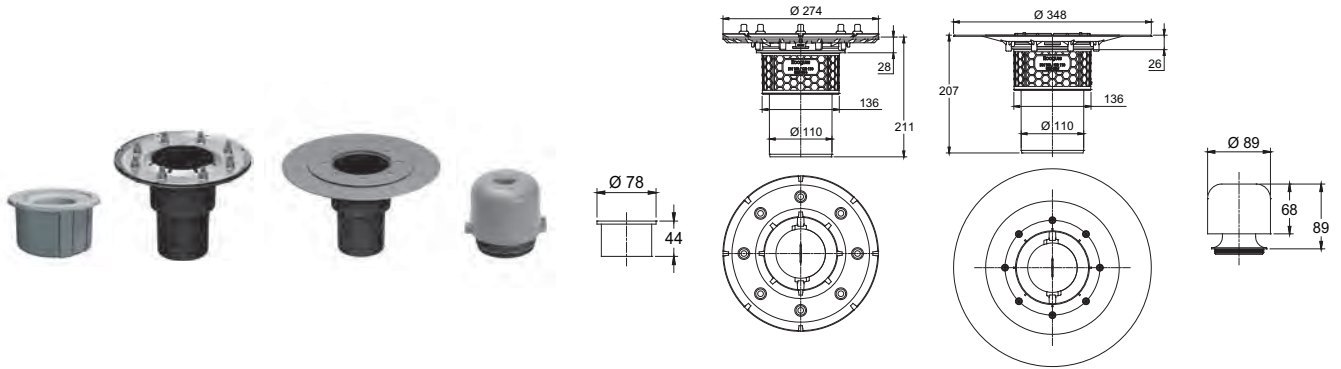

MEA PG Fire Kit | MEA PG compression-sealing flange | MEA PG adhesive flange drain | MEA PG. GV odour trap

MEA PG floor/ceiling drains, odour trap and fire kit

MG	Designation	Material	EDP-No. 010...	kg/unit	units/pallet
PG	For installation with mastic asphalt: MEA PG pressed gasket flange drain. Floor/ceiling drain eco die-cast, external Ø 274 mm, incl. mortar barrier. Connection option for vertical drain Ø 110 mm. Optionally prepared for fire protection fire-kit and/or odour trap.	Eco die-cast	141816	2.00	1
		Stainl. steel			
PG	For installation with OS coatings: MEA PG adhesive flange drain. Floor/ceiling drain eco die-cast, external Ø 348 mm, incl. mortar barrier. Connection option for vertical drain Ø 110 mm. Optionally prepared for fire protection fire-kit and/or odour trap.	Eco die-cast	141818	1.20	1
		Stainl. steel			
PG	MEA PG.GV odour trap suitable for floor/ceiling drains eco die-cast with pressure seal or adhesive flange, drain Ø 110 mm.	Plastic	141820	0.20	1
PG	MEA PG Fire-Kit, suitable for floor/ceiling drains eco die-cast, drain Ø 110 mm. In conjunction with eco die-cast drains, MEA PG odour trap, (EDP No. 010141820) fire resistance class R120 with DIBT approval Z-19.17-1719	Stainl. steel	141822	0.20	1

SEALANTS FOR MULTI-STOREY CAR PARK CHANNELS

MEARIN PG Sealants for multi-storey car park applications*

MG	Designation	Material	EDP-No. 010...	kg/unit	units/pallet
PG	SABA MS Floor sealant 600 ml in a bag, stable	MS-Polymer-Basis	152708	0,84	1
PG	SABA Primer 9102, 1 litre	-	155803	0,90	1
PG	SABA MS Floor Floor SL sealant 600 ml in a bag, self-leveling	MS-Polymer-Basis	152710	0.84	1
PG	Joint Cleaner solvent 48, 1 litre, Cleaner for adhesive flanks	Silan-Basis	155807	0,81	1
PG	Dispensing gun for SABA 600 ml bags	-	152707	0,79	1

* Exclusively for the sealing of channel systems exposed to rain water. Not suitable for the utilization in LAU plants, gas stations and similar building projects.